

**SGS-THOMSON**  
 MICROELECTRONICS

S G S-THOMSON

**3UF460F**  
**BUF460V**

T-33-15

## NPN TRANSISTOR POWER MODULE

- EASY TO DRIVE TECHNOLOGY (ETD)
- HIGH CURRENT POWER BIPOLAR MODULE
- VERY LOW  $R_{th}$  JUNCTION CASE
- SPECIFIED ACCIDENTAL OVERLOAD AREAS
- ISOLATED CASE (2500V RMS)
- EASY TO MOUNT
- LOW INTERNAL PARASITIC INDUCTANCE

### INDUSTRIAL APPLICATIONS:

- MOTOR CONTROL
- SMPS & UPS
- WELDING EQUIPMENT

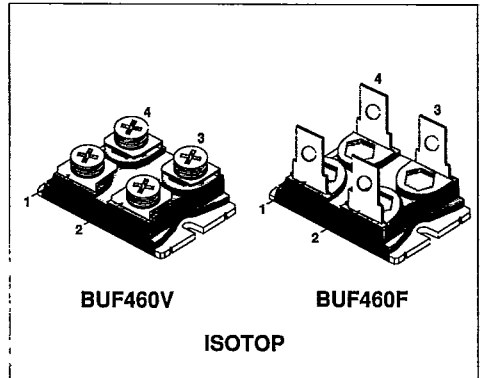

### INTERNAL SCHEMATIC DIAGRAM

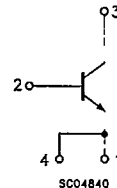

### ABSOLUTE MAXIMUM RATINGS

Symbol	Parameter	Value	Unit
$V_{CEV}$	Collector-Emitter Voltage ( $V_{BE} = -5$ V)	850	V
$V_{CEO(sus)}$	Collector-Emitter Voltage ( $I_B = 0$ )	450	V
$V_{EBO}$	Emitter-Base Voltage ( $I_C = 0$ )	7	V
$I_C$	Collector Current	80	A
$I_{CM}$	Collector Peak Current ( $t_p = 10$ ms)	160	A
$I_B$	Base Current	18	A
$I_{BM}$	Base Peak Current ( $t_p = 10$ ms)	27	A
$P_{tot}$	Total Dissipation at $T_c = 25$ °C	270	W
$T_{stg}$	Storage Temperature	-55 to 150	°C
$T_J$	Max. Operating Junction Temperature	150	°C
$V_{iso}$	Insulation Withstand Voltage (AC-RMS)	2500	V

**THERMAL DATA**

T-33-15

$R_{thj-case}$	Thermal Resistance Junction-case	Max	0.41	°C/W
$R_{thc-h}$	Thermal Resistance Case-heatsink With Conductive Grease Applied	Max	0.05	°C/W

**ELECTRICAL CHARACTERISTICS** ( $T_{case} = 25\text{ °C}$  unless otherwise specified)

Symbol	Parameter	Test Conditions	Min.	Typ.	Max.	Unit
$I_{CER}$	Collector Cut-off Current ( $R_{BE} = 5\ \Omega$ )	$V_{CE} = V_{CEV}$			0.2	mA
		$V_{CE} = V_{CEV}$ $T_j = 100\text{ °C}$			2	mA
$I_{CEV}$	Collector Cut-off Current ( $V_{BE} = -1.5V$ )	$V_{CE} = V_{CEV}$			0.2	mA
		$V_{CE} = V_{CEV}$ $T_j = 100\text{ °C}$			2	mA
$I_{EBO}$	Emitter Cut-off Current ( $I_c = 0$ )	$V_{EB} = 5\ V$			1	mA
$V_{CEO(SUS)}^*$	Collector-Emitter Sustaining Voltage	$I_c = 0.2\ A$ $L = 25\ mH$ $V_{clamp} = 450\ V$	450			V
$h_{FE}^*$	DC Current Gain	$I_c = 60\ A$ $V_{CE} = 5\ V$		15		
$V_{CE(sat)}^*$	Collector-Emitter Saturation Voltage	$I_c = 30\ A$ $I_B = 3\ A$		0.35		V
		$I_c = 30\ A$ $I_B = 3\ A$ $T_j = 100\text{ °C}$			2	V
		$I_c = 60\ A$ $I_B = 12\ A$		0.5		V
		$I_c = 60\ A$ $I_B = 12\ A$ $T_j = 100\text{ °C}$			2	V
$V_{BE(sat)}^*$	Base-Emitter Saturation Voltage	$I_c = 60\ A$ $I_B = 12\ A$		1.1		V
		$I_c = 60\ A$ $I_B = 12\ A$ $T_j = 100\text{ °C}$			1.5	V
$di_c/dt$	Rate of Rise of On-state Collector	$V_{CC} = 300\ V$ $R_C = 0$ $t_p = 3\ \mu s$ $I_{B1} = 18\ A$ $T_j = 100\text{ °C}$	150			A/ $\mu s$
$V_{CE(3\ \mu s)}$	Collector-Emitter Dynamic Voltage	$V_{CC} = 300\ V$ $R_C = 30\ \Omega$ $I_{B1} = 18\ A$ $T_j = 100\text{ °C}$		4	6	V
$V_{CE(5\ \mu s)}$	Collector-Emitter Dynamic Voltage	$V_{CC} = 300\ V$ $R_C = 30\ \Omega$ $I_{B1} = 18\ A$ $T_j = 100\text{ °C}$		2	3	V
$t_s$	Storage Time	$I_c = 30\ A$ $V_{CC} = 50\ V$		4.5	5	$\mu s$
$t_f$	Fall Time	$V_{BB} = -5\ V$ $R_{BB} = 0.2\ \Omega$		0.1	0.2	$\mu s$
$t_c$	Cross-over Time	$V_{clamp} = 400\ V$ $I_{B1} = 3\ A$ $L = 25\ \mu H$ $T_j = 100\text{ °C}$		0.3	5	$\mu s$
$V_{CEW}$	Maximum Collector Emitter Voltage Without Snubber	$I_{cWoff} = 80\ A$ $I_{B1} = 16\ A$ $V_{BB} = -5\ V$ $V_{CC} = 50\ V$ $L = 80\ \mu H$ $R_{BB} = 0.2\ \Omega$ $T_j = 125\text{ °C}$	400			V

\* Pulsed: Pulse duration = 300  $\mu s$ , duty cycle 1.5 %

Safe Operating Areas

Thermal Impedance

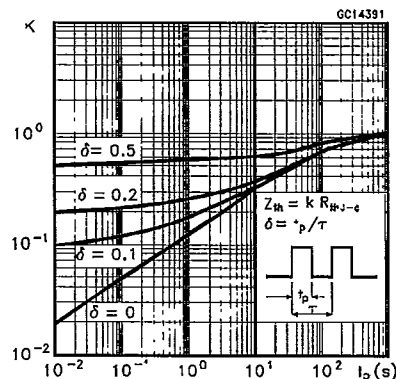
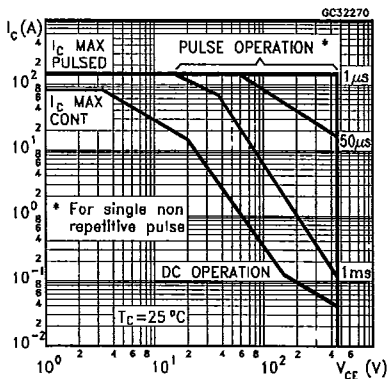

Derating Curve

Collector-Emitter Voltage Versus Base-Emitter Resistance

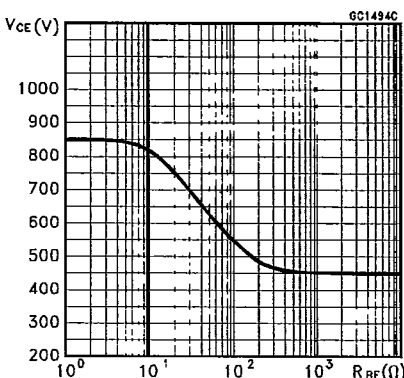
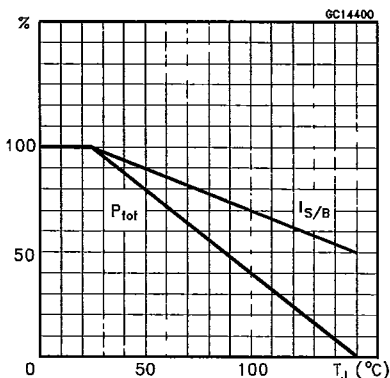

Collector-Emitter Saturation Voltage

Base-Emitter Saturation Voltage

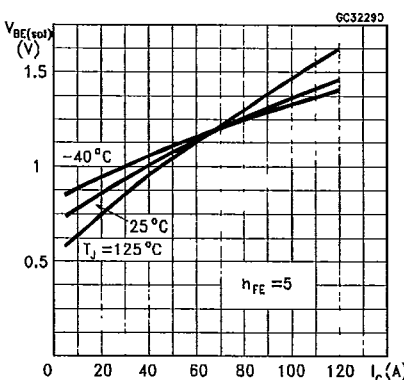
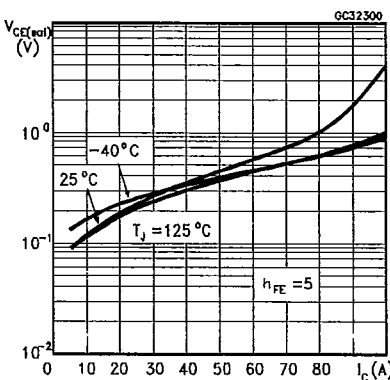

Reverse Biased SOA

Forward Biased SOA

T-33-15

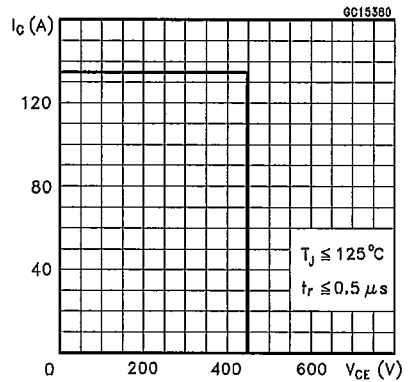
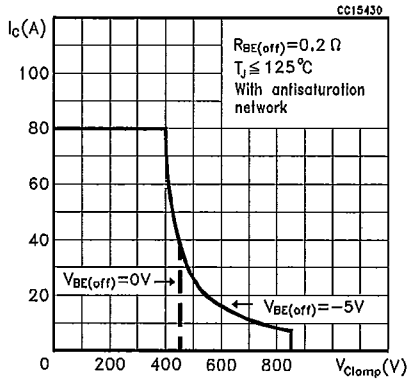

Reverse Biased AOA

Forward Biased AOA

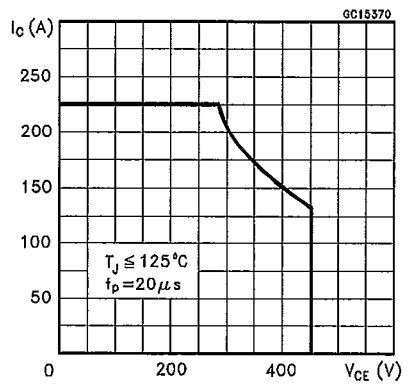
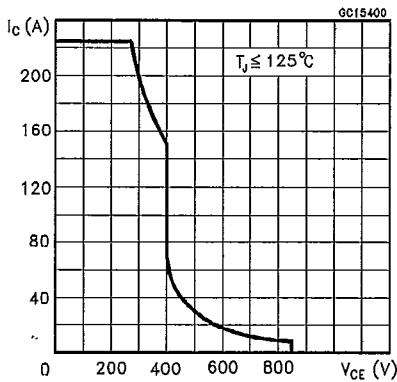

Switching Times Inductive Load

Switching Times Inductive Load Versus Temperature

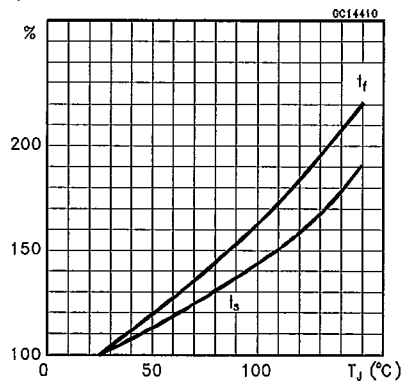
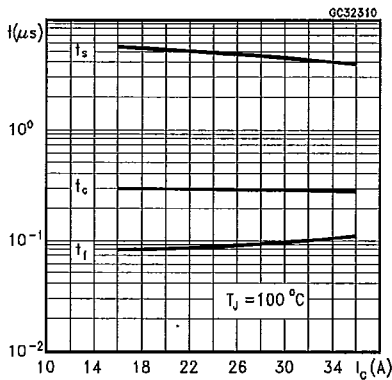

DC Current Gain

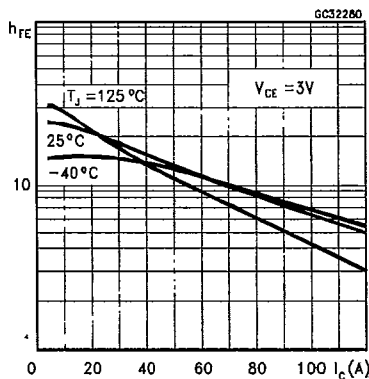

Turn-on Switching Test Circuit

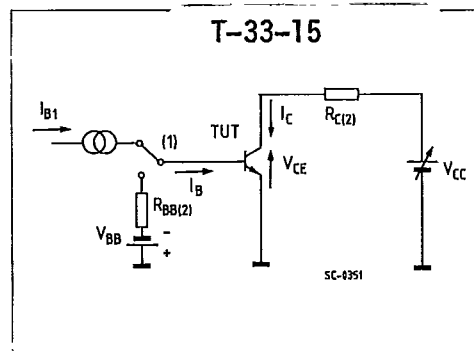

(1) Fast electronic switch (2) Non-inductive load

Turn-on Switching Waveforms

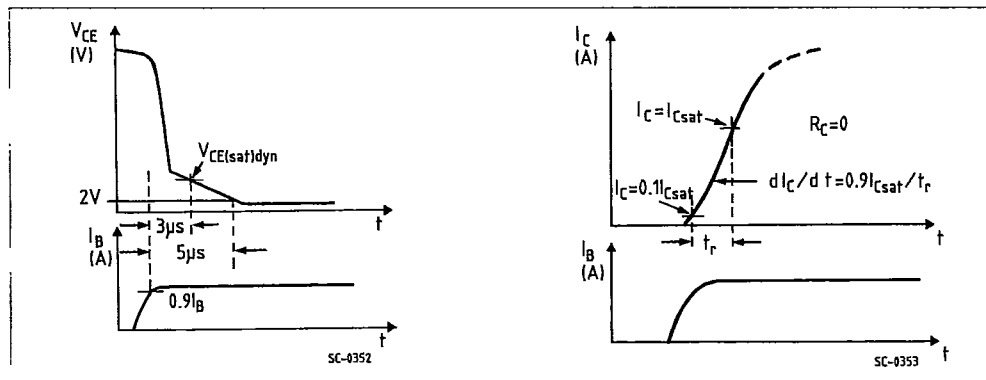

Turn-off Switching Test Circuit

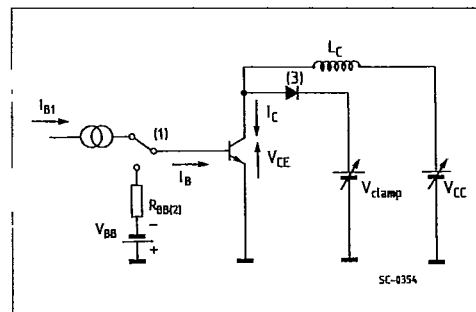

(1) Fast electronic switch (2) Non-inductive load (3) Fast recovery rectifier

Turn-off Switching Waveforms

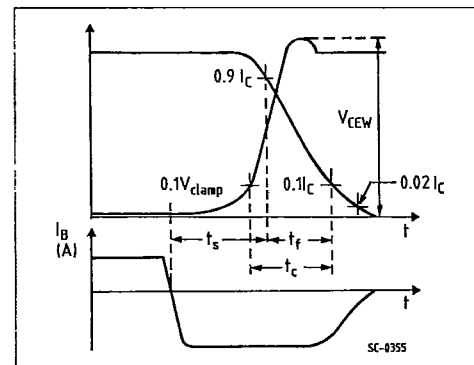

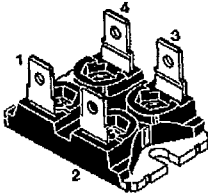

**ISOTOP**  
Fast-on version  
sales types with the suffix F

**MECHANICAL DATA**

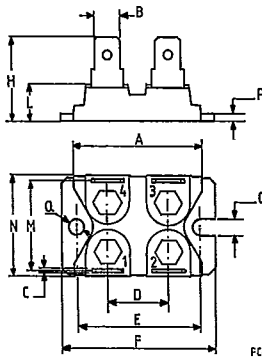

FC-9309

	DIMENSIONS			
	mm		Inches	
	min.	max	min.	max
A	31.5	31.7	1.240	1.248
B	6.2	6.4	0.244	0.252
C	0.75	0.85	0.029	0.033
D	14.9	15.1	0.586	0.590
E	30.1	30.3	1.185	1.193
F	38	38.2	1.496	1.503
G	4	-	0.157	-
H	20.3	20.7	0.799	0.815
L	8.9	9.1	0.350	0.358
M	22.4	23	0.881	0.905
N	25.2	25.4	0.992	1.000
P	1.95	2.05	0.076	0.080
Q	4	-	0.157	-

**PIN CONNECTIONS**

**MOSFET**

pin 1: Source      pin 2: Gate  
pin 3: Drain      pin 4: Source sensings

**DARLINGTON**

pin 1: Emitter      pin 2: Base1  
pin 3: Collector    pin 4: Base 2

**TRANSISTOR**

pin 1: Emitter      pin 2: Base  
pin 3: Collector    pin 4: Emitter sensing

Torque: Mounting  $1.3 \pm 0.2 \text{ N} \cdot \text{m}$  (max)

Weight: Package 25.5 g

Note: The mechanical data are the same for the 3 pin version (4th pin missing)

S G S-THOMSON

T-91-20

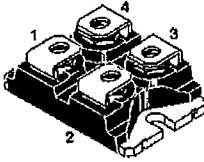

**ISOTOP**  
Screw version  
sales types with the suffix V

**MECHANICAL DATA**

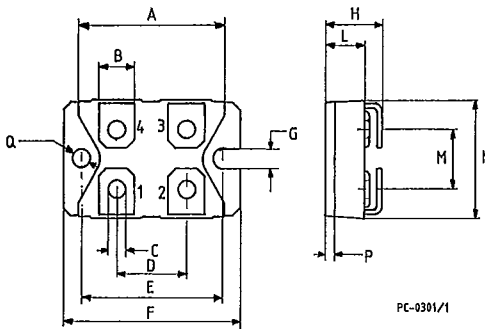

	DIMENSIONS			
	mm		Inches	
	min.	max	min.	max
A	31.5	31.7	1.240	1.248
B	7.8	8.2	0.307	0.322
C	4.1	4.3	0.161	0.169
D	14.9	15.1	0.586	0.590
E	30.1	30.3	1.185	1.193
F	38	38.2	1.496	1.503
G	4	-	0.157	-
H	11.8	12.2	0.464	0.480
L	8.9	9.1	0.350	0.358
M	12.6	12.8	0.496	0.503
N	25.2	25.4	0.992	1.000
P	1.95	2.05	0.076	0.080
Q	4	-	0.157	-

**PIN CONNECTIONS**

**MOSFET**

pin 1: Source      pin 2: Gate  
pin 3: Drain      pin 4: Source sensings

**DARLINGTON**

pin 1: Emitter      pin 2: Base1  
pin 3: Collector    pin 4: Base 2

**TRANSISTOR**

pin 1: Emitter      pin 2: Base  
pin 3: Collector    pin 4: Emitter sensing

Torque: Terminal  $1.3 \pm 0.2 \text{ N} \cdot \text{m}$  (max)  
Mounting  $1.3 \pm 0.2 \text{ N} \cdot \text{m}$  (max)

Weight: Package 29 g  
4 Screws: 7,5 g

Note: The mechanical data are the same for the 3 pin version  
(4th pin missing)

SGS-THOMSON

T-91-20

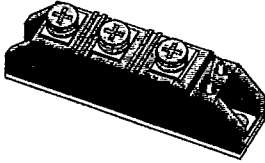

TRANSPACK (TO-240)

MECHANICAL DATA

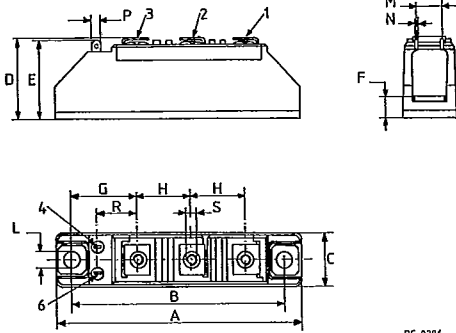

PC-0236

	DIMENSIONS			
	mm		Inches	
	min.	max	min.	max
A	91.5	92.5	3.602	3.641
B	79.75	80.25	3.140	3.160
C	19.5	20.55	0.767	0.809
D	29.00	31.00	1.141	1.220
E	28.8	30	1.134	1.181
F	8.5 typ.		0.334 typ.	
G	24.4 typ.		0.960 typ.	
H	19.5	20.5	0.767	0.807
L	6.2 typ.		0.244 typ.	
M	8.95	11.05	0.352	0.435
N	0.78	0.84	0.030	0.033
P	2.72	2.87	0.107	0.113
R	14	-	0.551	-
S	M5			

Torque: Terminal  $2.2 \pm 0.5 \text{ N} \cdot \text{m}$  (max)  
 Mounting  $3.5 \pm 0.5 \text{ N} \cdot \text{m}$  (max)

Weight: Package 110 g  
 Accessory 21 g

Note: The mechanical data are the same for the 2 power pin version (either pin 1 or pin 2 missing)